

# Turbo DX™ 2.0 Plug-In Charger User Guide



### SAVE THESE INSTRUCTIONS

This manual contains important instructions for the Turbo DX™ 2.0 Plug-In Charger that should be followed during installation, operation, and maintenance of the product.

### A NOTE ON CUSTOMER SUPPORT

**Please have your serial number ready**  
when contacting customer support.

Ampure  
1333 S. Mayflower Ave.  
Monrovia, CA 91016  
USA







+1 (888) 833-2148  
evscs@webasto.com

## Contents

- Section 1 – Introduction..... 3**
  - SYMBOL USAGE ..... 3
  - ABOUT YOUR TURBO DX 2.0 PLUG-IN CHARGER ..... 3
  - CHARGER COMPONENTS..... 6
  - SPECIFICATIONS ..... 7
- Section 2 – Using Your Charger..... 8**
  - KNOW YOUR INDICATOR LIGHTS..... 8
  - CHARGING YOUR VEHICLE ..... 9
  - A NOTE ON AUTO-RESTART ..... 10
  - CARE INSTRUCTIONS..... 10
- Section 3 – Troubleshooting ..... 10**
  - TROUBLESHOOTING GUIDE..... 10
  - APPENDIX ..... 13
  - CHARGER MOUNTING INSTRUCTIONS ..... 13
  - HIGH VOLTAGE WARNING..... 16
  - STATE OF CALIFORNIA PROPOSITION 65 WARNINGS..... 17
  - FCC INFORMATION..... 17
  - SAFETY FEATURES ..... 17

# Section 1 – Introduction

## SYMBOL USAGE

DANGER		Indicates information about safety practices which, if not followed, may result in serious injury or death.
DANGER		Risk of electric shock – Parts inside this product are a risk of shock to persons.
WARNING		Indicates information about safety practices which, if not followed, could result in personal injury or are necessary to prevent fire or equipment overheating.
		Do not operate the charger on an ungrounded power grid (e.g. IT networks). Only operate the charger on grounded power grids.
		Operating the charger at altitudes higher than 13,123 ft (4,000 m) above sea level is not recommended.
NOTE		Indicates helpful information for installation or usage, but does not contain personnel or equipment safety-related information.

## ABOUT YOUR TURBO DX 2.0 PLUG-IN CHARGER

The Turbo DX 2.0 Plug-In Charger is an easy-to-use, wall- or post-mountable power supply for your electric vehicle. The charger supplies and manages AC power to your electric vehicle and is compatible with a variety of battery electric vehicles and plug-in hybrids. The charger operates from a 120 - 240 VAC (Single Phase) 50 - 60 Hz power source. Key Features include:

- Wall- or post-mountable design
- Overheating protection
- Quick-read status indicators
- Overvoltage protection

WARNING



This product must be grounded. If it should malfunction or break down, grounding provides a path of least resistance for electric current to reduce the risk of electric shock. This product is equipped with an equipment-grounding conductor and a grounding plug. The plug must be inserted into an appropriate NEMA 14-50 outlet that is properly installed and grounded in accordance with all local codes and ordinances.

WARNING



Improper connection of the electrical outlet grounding conductor might result in a risk of electric shock. Check with a qualified electrician if you are uncertain whether or not the electrical outlet is properly grounded. Do not modify the plug provided with the product if it does not fit in the outlet. Have a proper outlet installed by a qualified electrician.

It is recommended that electrical outlets for use with your charger be installed by a licensed, qualified electrician. To avoid serious injury or death, installation must comply with the provisions of the National Electric Code (NEC) and all local codes. In cases of conflict between local codes and the NEC, local codes shall take precedence.

WARNING



Do NOT DROP the charger control box or coupler.

Do NOT use if stored outside the temperature range specified on the following page.

WARNING



If the cable becomes loose or separated from the control box or the charger coupler, DO NOT ATTEMPT TO REPAIR THE CABLE YOURSELF. Contact your local Ampure dealer for assistance.

WARNING



When using your Turbo DX 2.0 Plug-In Charger, basic precautions should always be followed, including the following:

- See the warnings on the charger control box. Read the warnings before operating the product for the first time. Read all instructions in this guide before using this product.
- Never use the charger with an extension cord.
- Do not plug into a worn or severely degraded outlet.
- Shock hazard – be sure the plug is fully inserted into the wall outlet so there are no exposed blade surfaces.
- Children should be supervised when in the vicinity of the charger while plugged in.
- Do not put insert fingers into the electric charge coupler.
- To reduce the risk of fire, only connect the charger to a circuit with 40 amps maximum branch circuit overcurrent protection in accordance with NEC and local electrical code.
- Do not use in a commercial garage classified for internal combustion engine vehicles due to vapors of flammable liquids (gasoline) being present.

## CAUTION



CAUTION: Do not operate the charger in a temperature outside its operation range of -22°F to +122°F (-30°C to +50°C).

CAUTION: Should the charger be stored for a prolong period of time, be sure to store it in a clean dry place with a temperature range between -22°F to +185°F (-30°C to 85°C).

## WARNING



WARNING: Do not plug the charger into an electrical outlet submerged in water or covered in snow.

WARNING: Do not use the charger during a severe rain, snow or an electrical storm.

WARNING: Avoid moisture, water, snow and foreign objects at all times.

## NOTE



This product will not charge and will give a fault indication if ground is not present. Do not replace the plug with retrofit component – there are critical safety devices in the plug, and the device will not operate if it is replaced. Do not modify. Do not use any third party adapters in conjunction with the plug as this can lead to a fire. Use only accessories and replacement parts from Ampure with an approved NEMA 14-50 outlet. The plug must be in good condition and meet up-to-date NEC code. Make sure cable is completely unwound before charging.

## CHARGER COMPONENTS

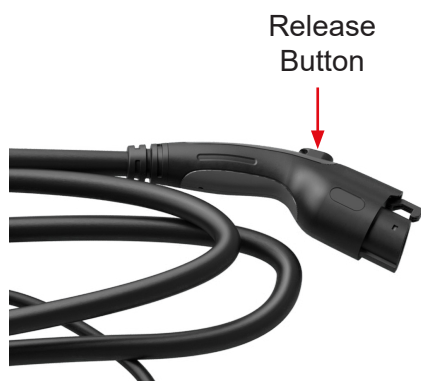

SAE Charger Coupler  
(North America)

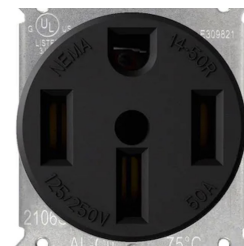
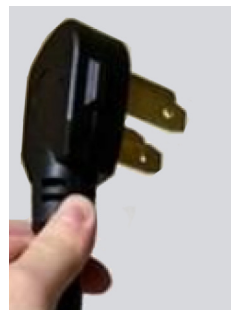

NEMA 14-50R Outlet

Your Turbo DX 2.0 Plug-In Charger comes standard with a NEMA 14-50 plug.

## SPECIFICATIONS

Turbo DX 2.0 Plug-In Charger	SAE (North America)
Voltage:	120-240 VAC
Maximum current:	32 amps max continuous
Frequency:	50-60 Hz
Power draw at idle:	< 2 watts
During charging:	< 4 watts
Cable length:	Approximately 25 ft (7.6 m)
Weight:	12 lbs (5.5 kg)
Operating temperature:	-40°C (-40°F) to +80°C (176°F)
Storage temperature:	-40°C (-40°F) to +80°C (176°F)
CCID environmental rating:	NEMA Type 4
Ventilation:	Not required

Specifications are subject to change without notice.

## Section 2 – Using Your Charger

### KNOW YOUR INDICATOR LIGHTS

The Indicator light on your charger is the first thing you will notice when you are about to plug or unplug your vehicle. Before getting started, here is a simple explanation of the indicators.

#### AMBER — FAULT

The AMBER FAULT Indicator illuminates to show the charger is rebooting after an error. Refer to the Troubleshooting Guide in Section 3 for more information.

#### BLUE — STATUS

When plugged into the wall outlet, the BLUE STATUS Indicator illuminates to show the charger is ready to use. During charging, the BLUE STATUS indicator pulses ON and OFF every two seconds. Refer to the Troubleshooting Guide in Section 3 for more information.

#### RED — TROUBLE

The RED TROUBLE Indicator illuminates when the charger detects an error. If the RED TROUBLE Indicator illuminates, the charger will not deliver power to the vehicle. The error must be corrected before a charging cycle can begin or continue. Refer to the Troubleshooting Guide in Section 3 for more information.



#### NOTE



The following indicates a normal startup safety check.

1. When first plugged into a wall socket, the AMBER, BLUE and RED indicators blink once.
2. Then the BLUE Indicator turns ON, followed by a blink of the RED indicator.
3. Lastly, the BLUE indicator turns OFF, then ON again.



## CHARGING YOUR VEHICLE

1. Make sure the vehicle is in park (P).
2. Insert the plug firmly into the appropriate wall outlet.
3. When the wall plug is inserted the AMBER, BLUE and RED indicators will blink once. Then the BLUE Indicator turns ON, followed by a blink of the RED indicator. Lastly, the BLUE indicator turns OFF, then ON again.
4. Plug the coupler into your vehicle's charging inlet. When the coupler is fully inserted, there will be an audible clicking sound.
5. When charging begins, the BLUE STATUS Indicator pulses ON and OFF approximately every two seconds.
6. When charging ends, the BLUE STATUS Indicator illuminates solid blue.
7. To disconnect the coupler from the vehicle charge port, press the release button on the coupler, then pull the coupler away from the vehicle.

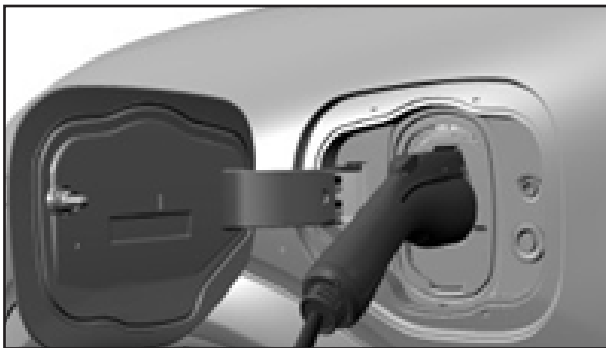

**NOTE**  To safely discontinue charging at any time, follow the disconnect instructions in Step 7. Charging will automatically and safely stop. The BLUE STATUS Indicator remains ON (without blinking) when the coupler is removed.

**NOTE**  When plugging the charger into an unfamiliar wall outlet, it is good practice to take few minutes to observe the charging process and confirm it is supplying the expected AC charging power before leaving the charger unattended.

The RED TROUBLE Indicator illuminates if it is not charging. The unit will turn OFF if a breaker or infrastructure GFI is tripped.

For more information about how to charge your vehicle, including charge settings and scheduling, refer to the vehicle owner's manual.

## A NOTE ON AUTO-RESTART

The Auto-Restart feature helps to ensure that your vehicle is charged and ready for use when needed. A charge may be interrupted if an error is detected. Charging resumes once the error is no longer detected. The RED TROUBLE Indicator illuminates during an error condition.

The exception to immediate Auto-Restart is when the interruption is due to a ground fault circuit interruption (GFI/GFCI). The charger will attempt to restart 15 minutes after this happens. After a fourth attempt to restart, the charger shuts down and the RED TROUBLE Indicator stays ON.

If the fault persists, do not continue to try to charge your vehicle. Contact Ampure Customer Support (see page 3).

## CARE INSTRUCTIONS

Do not use hard cleaners or solvents as this may damage your charger. Do not kink or place undue stress on the charger cables.

# Section 3 – Troubleshooting

## TROUBLESHOOTING GUIDE:

Please refer to this Troubleshooting Guide for possible solutions to common errors or difficulties with charging your vehicle using this charger.

**NOTE**  Do not attempt to repair or service the charger yourself. There are no user serviceable parts inside this product. Failure to follow these instructions may void the warranty.

A RED TROUBLE Indicator may be triggered by several sources including the charger, the utility service, or the vehicle. See the Troubleshooting tips below.

The RED TROUBLE Indicator turns ON when the charger detects an error, whether it is connected to your vehicle or not. When the RED TROUBLE Indicator is ON, the charger will not deliver power to the vehicle. The error must be corrected before charging begins or resumes.

Charger Mode	Amber Indicator	Blue Indicator	Red Indicator	Explanation	Action
Unpowered	OFF	OFF	OFF	The charger is not powered. If indicators are OFF after plugging the grid plug into the outlet, there may be no power from the outlet.	<p>Confirm the outlet is operational and the circuit breaker is in the ON position. Try using another outlet.</p> <p>Confirm the grid plug is fully inserted. Confirm the plug is not severely degraded.</p> <p>If the error persists, contact Ampure Customer Support.</p>
Charging	OFF	PULSING	OFF	The charger is successfully charging.	No action required.
Standby	OFF	ON	OFF	The charger is powered and ready to charge. The charger is not charging the vehicle.	<p>If you expect the charger to be charging the vehicle, confirm the vehicle coupler is properly inserted into the vehicle.</p> <p>Check and adjust your charging time preferences in sync.</p> <p>If the vehicle is still not charging, contact Ampure Customer Support.</p>
Rebooting	ON	ON	ON	The charger is automatically recovering after encountering an error.	<p>Wait for the charger to return to standby.</p> <p>If the charger cycles for more than 2-3 minutes, unplug the vehicle coupler.</p> <p>Unplug, then reinsert the grid plug.</p> <p>If the issue persists, contact Ampure Customer Support.</p>
Charging reduced	ON	PULSING	OFF	The charger is charging at a reduced rate due to overheating.	<p>Confirm the grid plug and control box are properly connected.</p> <p>Disconnect, then reconnect the grid plug.</p> <p>The charging rate may be reduced under high ambient temperatures or if the control box is in direct sunlight.</p> <p>Should the error persist after the ambient temperature is reduced and the control box is no longer in direct sunlight, contact Ampure Customer Support.</p>

Charger Mode	Amber Indicator	Blue Indicator	Red Indicator	Explanation	Action
Charging reduced (AC plug or wall outlet)	1 FLASH	PULSING	OFF	The charger is charging at a reduced rate due to overheating of the grid plug or the wall outlet.	<p>Confirm the grid plug is properly connected.</p> <p>Disconnect, then reconnect the grid plug.</p> <p>The charging rate may be reduced under high ambient temperatures or if the control box is in direct sunlight.</p> <p>Should the error persist after the ambient temperature is reduced and the control box is no longer in direct sunlight, contact Ampure Customer Support.</p>
User troubleshooting	ON	OFF	OFF	The charger has encountered a fault that requires troubleshooting.	<p>Confirm the grid plug is properly connected.</p> <p>Disconnect, then reconnect the grid plug.</p> <p>The charging rate may be reduced under high ambient temperatures or if the control box is in direct sunlight.</p> <p>Should the error persist after the ambient temperature is reduced and the control box is no longer in direct sunlight, contact Ampure Customer Support.</p>
Non-recoverable fault	OFF	OFF	ON	There is an internal fault in the charger that cannot be recovered.	If the error persists, contact Ampure Customer Support.
Non-recoverable fault (grid plug)	OFF	OFF	1 FLASH	There is an internal fault in the grid plug that cannot be recovered.	<p>Contact Ampure Customer Support for assistance.</p> <p>If your warranty has expired, you can order a replacement from Ampure Customer Support.</p>
Ground leakage fault	OFF	OFF	PULSING	Electrical current is leaking through a potentially unsafe path.	<p>Potential shock hazard – immediately turn OFF the circuit breaker for the outlet within the home.</p> <p>Discontinue use.</p> <p>Contact Ampure Customer Support about obtaining a replacement.</p>

# APPENDIX

## CHARGER MOUNTING INSTRUCTIONS

*NOTE: The images contained on pages 13-14 are for illustration purposes only. Your actual product may differ in appearance.*

The Turbo DX 2.0 comes with mounting screws in the box, and the wall-mounting bracket comes pre-installed and secured to the back of the control box (below left).

When choosing a location to mount the control box, it should be mounted to a wall stud (below center) within reach of the power outlet (below right), and the vehicle coupler should be easily extended to the vehicle's charge receptacle.

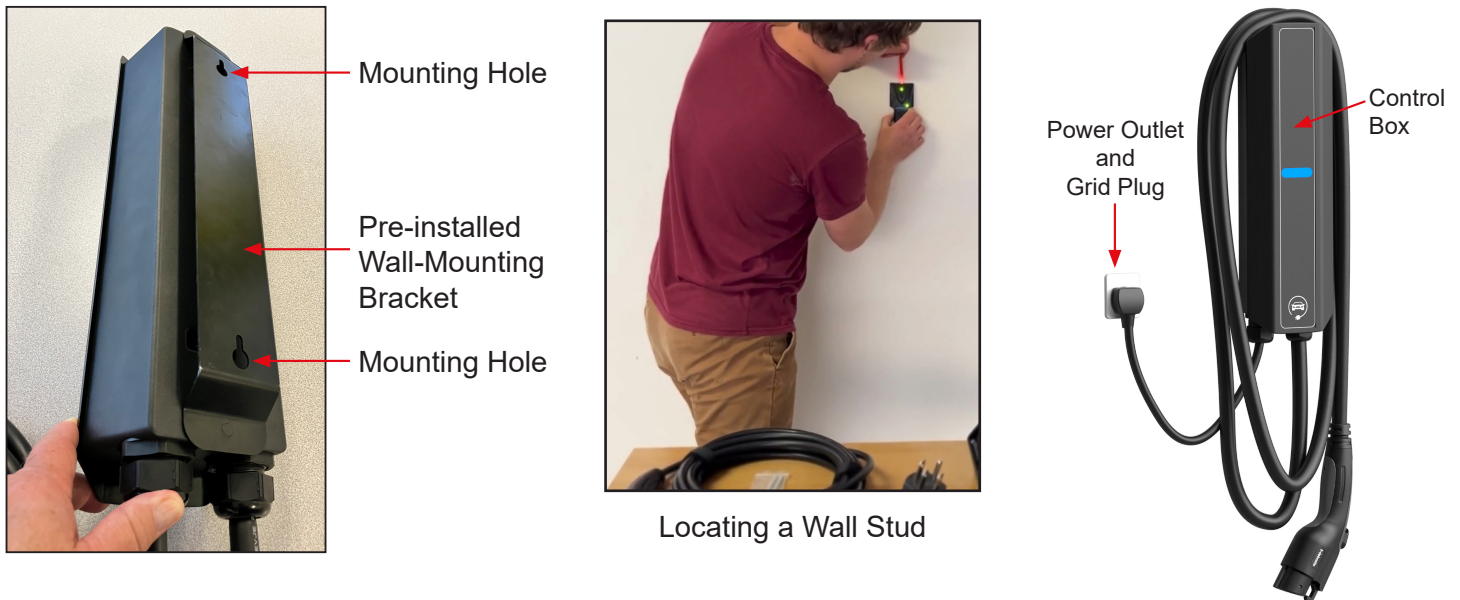

### PLEASE NOTE THE FOLLOWING:

- Masonry wall installation requires the use of appropriate fasteners.
- In compliance with the American Disabilities Act and the National Electrical Code, the NEMA 14-50 outlet and the top of the Turbo DX 2.0 charger should be no higher than 48 inches (1220 mm) above the floor, and no lower than 15 inches (380 mm) above the floor. This will ensure that individuals with disabilities can plug in the Turbo DX 2.0 grid plug and charger coupler.

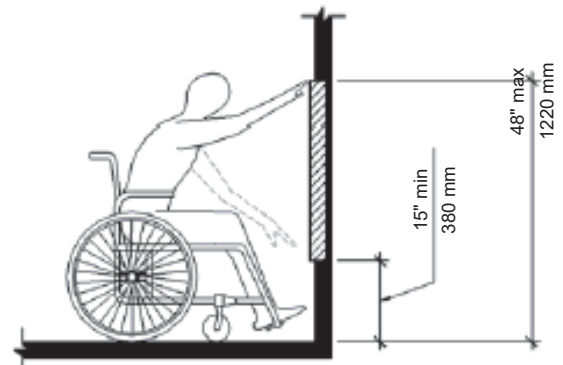

Graphic: U.S. Department of Justice  
Civil Rights Division

1. Once you've selected the location for mounting the control box, pre-drill the holes using a 1/8-inch drill bit.
2. After the holes are drilled, use a Phillips head screwdriver to install the top #10 roundhead screw into the wall, leaving 0.1 inch (3 mm) of the screw shaft exposed as shown to the right.

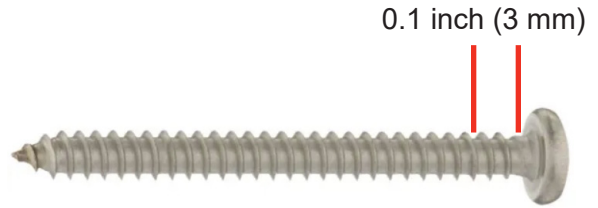

3. Measure 10.75 inch (273 mm) **below** the top mounting screw to mark the location for mounting the bottom screw, then install the second #10 screw into the wall.

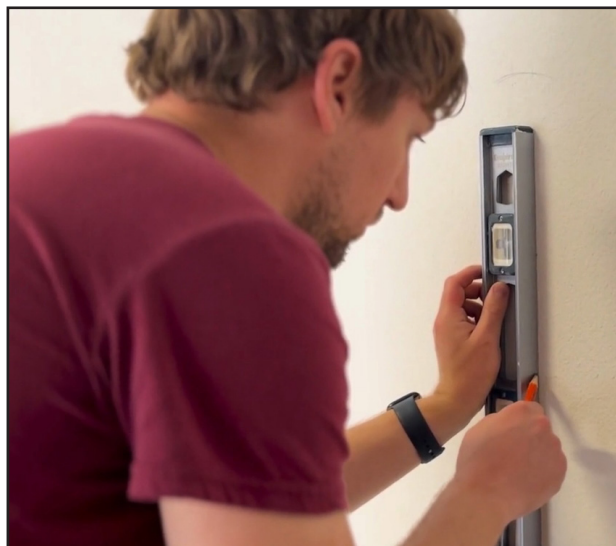
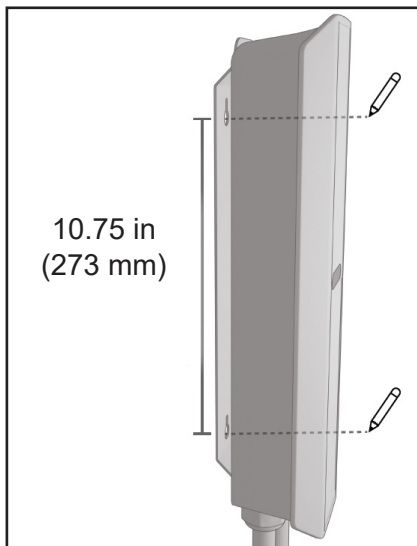

4. Carefully hang the control box bracket onto the screw heads and gently lower the control box to secure it.









5. Plug the grid cord into the power outlet – the control box will automatically turn ON.

The Turbo DX 2.0 is now ready for charging an electric vehicle.



## HIGH VOLTAGE WARNING

- DANGER  High voltage is present in your electric meter housing and power distribution service panel. Contact with high voltage can cause death or serious personal injury.
- DANGER  Risk of electric shock – Parts inside this product have a risk of shocking persons.
- WARNING  DO NOT operate your charger with a damaged grid plug, charger coupler, cables or control box. Visually inspect the cable, charge coupler and charger module for damage before each use. Do not operate if any visual damage is apparent anywhere, then contact Ampure Customer Support (page 3).
- WARNING  ALWAYS position the charger cable and coupler to prevent those components from being driven over, stepped on, tripped over, damaged or stressed.
- WARNING  Use the charger only to supply power to electric vehicles equipped with an SAE J1772 compliant vehicle receptacle. For more information, refer to the vehicle owner's manual.
- NOTE  Disconnect the charger from the wall outlet before cleaning it. To clean the charger, wipe it with a clean cloth dampened with water or a mild detergent solution suitable for use on automobile paint. Do not use chemicals or solvents.



## STATE OF CALIFORNIA PROPOSITION 65 WARNINGS

WARNING



This product contains a chemical known to the State of California to cause cancer or birth defects or other reproductive harm.

## FCC INFORMATION

This device complies with Part 15 of the FCC Rules. Operation is subject to the following two conditions:

- This device may not cause harmful interference.
- This device must accept any interference received, including interference that may cause undesired operation.

This product has been designed to protect against Radio Frequency Interference (RFI). However, there are some instances where high-powered radio signals or nearby RF- producing equipment could affect operation.

If you suspect your charger is receiving interference, take the following steps before contacting Customer Support for service:

1. Relocate away from electrical appliances or equipment.
2. Turn off nearby electrical appliances or equipment during charging.

Important! Changes or modifications to this product by anyone other than an authorized service provider will void FCC compliance and the product will not be serviceable.

## SAFETY FEATURES

The Turbo DX 2.0 Plug-In Charger is designed with your safety as the highest priority and includes the following safety features to protect against the risk of electric shock:

- **Service Ground Check:** The charger constantly checks for the presence of a service ground connection. If the service ground ever fails, the charger RED TROUBLE Indicator turns ON and shuts down power to the vehicle.
- **Thermal Event Sensor:** The charger module senses out-of-ordinary thermal events and will decrease charging current or shut the unit down if required.
- **GFCI Protection:** The charger is equipped with a ground fault circuit interruption (GFI/GFCI) reaction system to protect against electric shock. If the charger module detects an output ground fault, it will shut down power to the output cable and illuminate the RED TROUBLE indicator.
- **Insulation:** The charger module, grid plug, cable assembly, and charge coupler are completely insulated (no exposed live parts) to protect against electric shock.
- **Unintentional Disconnection:** The charge coupler is designed to minimize unintentional disconnection. A pilot signal wire in the cable and charge coupler eliminates the possibility of electric shock when not connected to a vehicle or if an unintended disconnect occurs during a charge. Disconnection during charging is safe.

Ampure  
1333 S. Mayflower Ave., Suite 100  
Monrovia, CA 91016  
USA

Doc ID 5913386 • 07/24 • © Ampure 2024